

# RSIC-1™ SOUND ISOLATION CLIP GUIDE

## RSIC-1 Installation



**RSIC-1**

*Acoustical Surfaces, Inc.  
A Master Distributor for  
PAC INTERNATIONAL, INC.*



**ACOUSTICAL | SURFACES, INC.**

PAGE 1

*Celebrating Over 40 Years - SOUNDPROOFING, ACOUSTICS, NOISE & VIBRATION SPECIALISTS!*  
952.448.5300 | 800.448.0121 | sales@acousticalsurfaces.com | www.acousticalsurfaces.com

# RSIC-1™ SOUND ISOLATION CLIP GUIDE

## RSIC-1 Installation Cont.

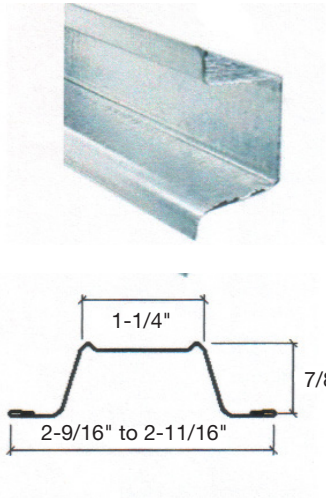

### Drywall Furring Channel:

- **Minimum Requirements:** 0.0018" (18 mil) thick 25 gauge, hemmed edge detail required on all 25 gauge furring channel. Meets or exceeds SFIA and SSMA requirements.
- **Depth:** 7/8 inch.
- **Width Bottom:** 2-9/16" to 2-11/16" inch wide nominal.
- **Width Top:** 1-1/4 inch wide.
- **Max Spacing:** 24 inches oc.

Splice drywall furring channel (hat track) with 6 inch overlap in mid span (between two clips) secure with 18 ga tie wire, or two 7/16" framing screws.

### Drywall Furring Channel Overlap:

- Overlap drywall furring channel mid span in between RSIC clips and fasten together with 2 steel framing screws.

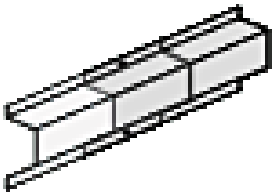

### Resilient Sound Isolation Clip (RSIC-1):

- **Maximum Spacing:** 48 inches on center.
- **Maximum Acoustical Design Load:** 36 lbs.



### RSIC-1 Dimensions:

- RSIC-1 clip 3" tall
- RSIC-1 clip 1-1/4" deep
- RSIC-1 and drywall furring channel 1-5/8" deep

### Fasteners:

- **RSIC-1 to Wood:** #8 x 2-1/2 inch minimum size coarse thread screw. (Recommended #12 or 10 x 2-1/2 inch hex head).
- **RSIC-1 to Steel:** #8 x 1-5/8 inch minimum size fine thread screw. (Recommended #12 or #10 x 1-5/8 inch hex head).
- **DO NOT** fasten Resilient Sound Isolation Clips (RSIC-1) to framing members with nails. Use only approved screws.

STOP NOISE

ACOUSTICAL | SURFACES, INC.

PAGE 2

Celebrating Over 40 Years - SOUNDPROOFING, ACOUSTICS, NOISE & VIBRATION SPECIALISTS!  
952.448.5300 | 800.448.0121 | sales@acousticalsurfaces.com | www.acousticalsurfaces.com

# RSIC-1™ SOUND ISOLATION CLIP GUIDE

## RSIC-1 Installation Cont.

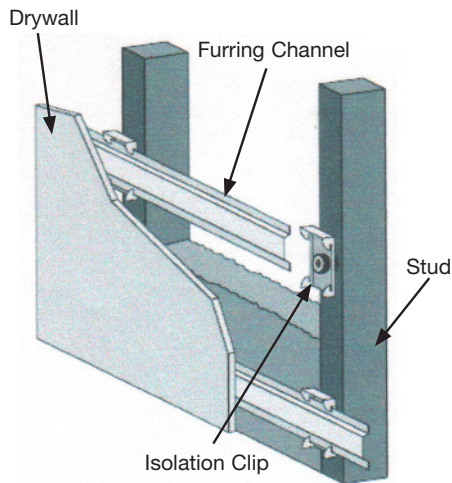

### Walls: One and Two layers of 5/8" Gypsum Board

- Resilient Sound Isolation Clip (RSIC-1) shall be 48 x 24 inches maximum on center, (horizontal).
- Fasten the Resilient Sound Isolation Clip (RSIC-1) to the substrate with a fastener approved for a minimum pull-out and shear of 120 lbs.
- Ensure the internal metal ferrell is tight to the substrate.
- Locate the first row of RSIC-1 clips within 3 inches from the floor and within 6 inches from the ceiling.
- Snap in the drywall furring channel (hat track) into the RSIC-1 clips (horizontal for walls). (See page 3 for splice details). Channel max spacing 24 inches oc.
- Place 1/4" (minimum) shim on floor to fully support the gypsum board.
- Install the gypsum board from the bottom up leaving a 1/4" min. gap around perimeter of the wall.
- **ONLY** remove the shims after ALL the gypsum board is completely screwed to ALL the drywall furring channels. Make sure every screw (floor to ceiling and wall to wall) is installed as required by the assembly design, in every layer of gypsum board before removing the shims at the floor. The shims are critical to ensure best results.
- Caulk around the entire perimeter of the gypsum board. Use fire and smoke rated acoustical sealant where required.

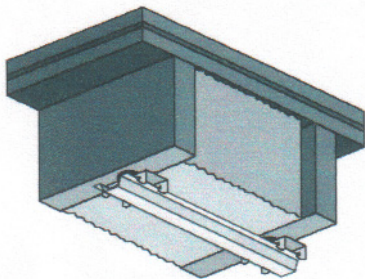

### Ceilings One and Two Layers of 5/8" Gypsum Board

- Resilient Sound Isolation Clips (RSIC-1) shall be 48 x 24 inches maximum on center.
- Fasten the Resilient Sound Isolation Clip (RSIC-1) to the substrate with a fastener approved for a minimum pull-out and shear of 120 lbs.
- Ensure the internal metal ferrell is tight to the substrate.
- Locate the first row of RSIC-1 clips within 8 inches of the wall at each end of a run.
- Snap in the drywall furring channel (hat track) into the RSIC-1 clips. Channel max spacing 24 inches oc.
- Install the gypsum board leaving a 1/4" min. gap around the perimeter of the ceiling.
- Caulk around the entire perimeter of the gypsum board. Use fire and smoke rated acoustical sealant where required.

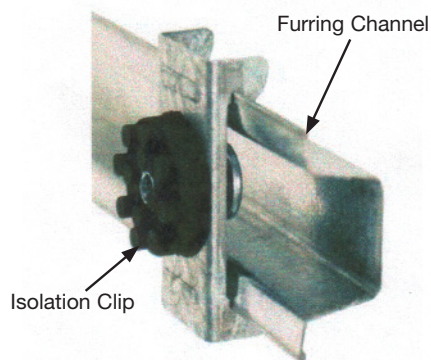

### General Information:

- Refer to [www.UL.com](http://www.UL.com) for complete installation details on all fire resistive assembly designs.
- Resilient Sound Isolation Clip (RSIC-1), furring channel (hat track) and gypsum board shall not carry heavy loads such as cabinets or bookshelves, dropped ceilings, light fixtures, speakers, televisions, headboards, or floating vanities.
- Splice furring channel (hat track) with 6 inch overlap in mid span, secure with 18 ga. tie wire or with two framing screws (7/16").
- Seal all potential air leaks with non-hardening acoustical caulking to achieve best noise control results. Use fire rated sealant where required.
- When attaching the RSIC-1 clips to a steel stud the minimum allowable thickness is 20 ga. (0.030).

STOP NOISE

ACOUSTICAL | SURFACES, INC.

PAGE 3

Celebrating Over 40 Years - SOUNDPROOFING, ACOUSTICS, NOISE & VIBRATION SPECIALISTS!

952.448.5300 | 800.448.0121 | [sales@acousticalsurfaces.com](mailto:sales@acousticalsurfaces.com) | [www.acousticalsurfaces.com](http://www.acousticalsurfaces.com)

# RSIC-1 SOUND ISOLATION CLIP GUIDE

## RSIC-1 Installation Cont.

Applications Recommendations for Wall and Ceilings  
Wood or Steel Framing

INSTALLING RESILIENT SOUND ISOLATION CLIPS (RSIC-1)

### RSIC CLIPS at 24" OC.

RSIC-1 Wall or Ceiling System Framing at 24" O.C.

RSIC-1 Clips at 24" x 48" O.C. 1 or 2 Layers of 5/8" Gypsum Board

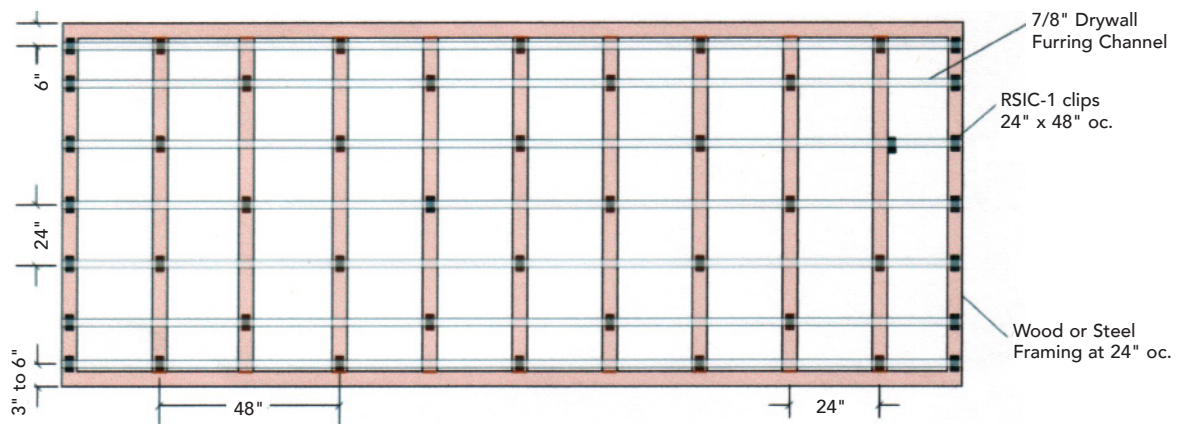

RSIC-1 Wall or Ceiling System Framing at 16" O.C.

RSIC-1 Clips at 24" x 48" O.C. 1 or 2 Layers of 5/8" Gypsum Board

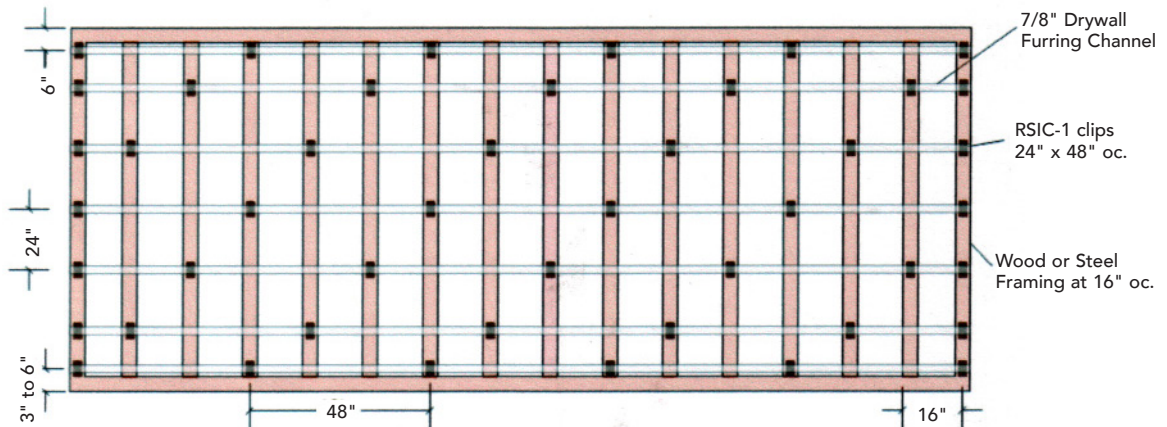

STOP NOISE

ACOUSTICAL | SURFACES, INC.

PAGE 4

Celebrating Over 40 Years - SOUNDPROOFING, ACOUSTICS, NOISE & VIBRATION SPECIALISTS!

952.448.5300 | 800.448.0121 | sales@acousticalsurfaces.com | www.acousticalsurfaces.com

# RSIC-1 SOUND ISOLATION CLIP GUIDE

## RSIC-1 Installation Cont.

Applications Recommendations for Wall and Ceilings  
Wood or Steel Framing

INSTALLING RESILIENT SOUND ISOLATION CLIPS (RSIC-1)

### RSIC CLIPS at 16" O.C.

RSIC-1 Wall or Ceiling System Framing at 24" O.C.

RSIC-1 Clips at 16" x 48" O.C. 3 Layers of 5/8" Gypsum Board

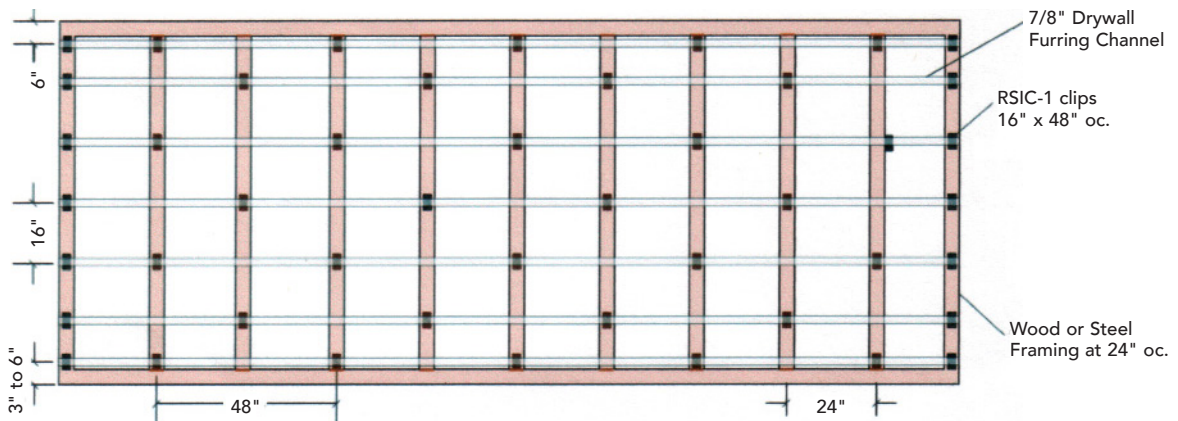

RSIC-1 Wall or Ceiling System Framing at 16" O.C.

RSIC-1 Clips at 16" x 48" O.C. 3 Layers of 5/8" Gypsum Board

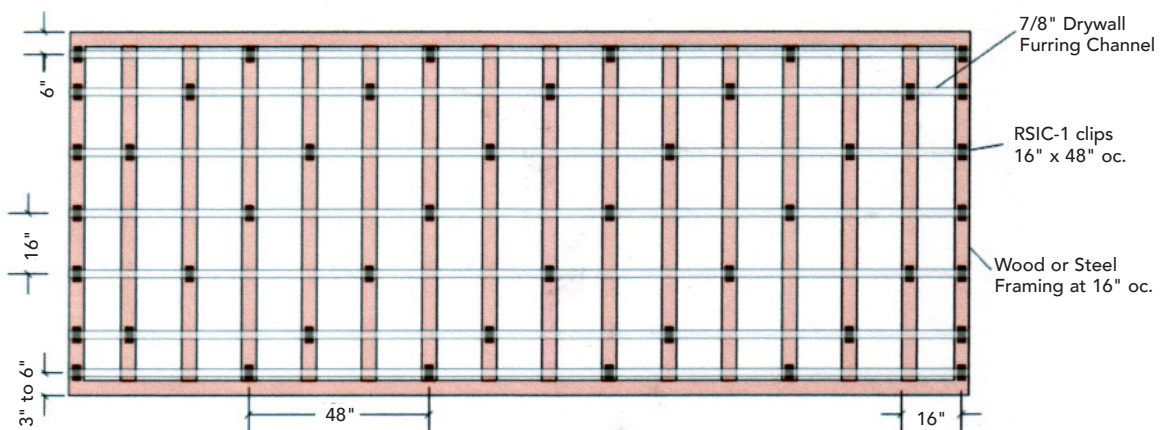

**ACOUSTICAL** | SURFACES, INC.

PAGE 5

*Celebrating Over 40 Years - SOUNDPROOFING, ACOUSTICS, NOISE & VIBRATION SPECIALISTS!*  
952.448.5300 | 800.448.0121 | sales@acousticalsurfaces.com | www.acousticalsurfaces.com

# RSIC-1 SOUND ISOLATION CLIP GUIDE

## RSIC-1 Installation Cont.

Applications Recommendations for Wall and Ceilings  
Wood or Steel Framing

INSTALLING RESILIENT SOUND ISOLATION CLIPS (RSIC-1)

### RSIC CLIPS Additional Details

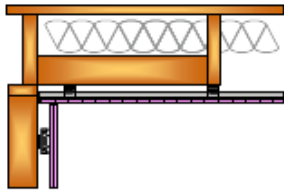

RSIC-1 clip added blocking when there is not a joist within 6" of the end of the ceiling:

- Add min 2 x 4 blocking that travels from joist to head of wall, or joist to joist to support RSIC-1 clips within 6" of the end of the ceiling.

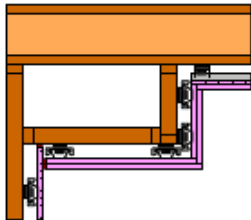

RSIC clip soffit installation:

- Soffits should be hard framed and RSIC clips installed to the outside of the soffit frame to support the gypsum board.

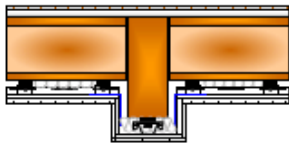

RSIC clip beam installation:

- Beams can be floated with 90 deg. angle or supported with a single run of RSIC clips and channel at the lowest point.

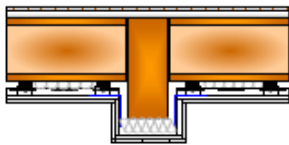

RSIC clip transition or interruption installation:

- The furring channel may be interrupted by HVAC, Light Fixtures, Sprinkler Heads, or other items that need to penetrate the ceiling.
- The furring channel may be trimmed to allow this interruption when stringbacks are placed perpendicular to the main runs of channel and are supported by the adjacent furring channel runs, and the interruption is box framed using drywall furring channel.
- Additional RSIC-1 clips may be added to support the additional weight of a light box or light fixture. Add one RSIC-1 clip for every 36 lbs added to the ceiling at those locations.

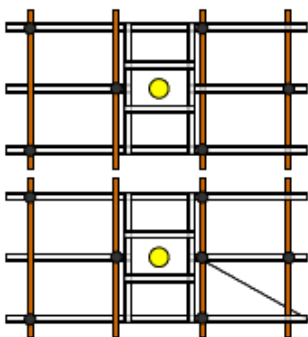

Optional RSIC-1 clip added to support the end of the channel.

STOP NOISE

ACOUSTICAL | SURFACES, INC.

PAGE 6

Celebrating Over 40 Years - SOUNDPROOFING, ACOUSTICS, NOISE & VIBRATION SPECIALISTS!

952.448.5300 | 800.448.0121 | sales@acousticalsurfaces.com | www.acousticalsurfaces.com

# RSIC-1 SOUND ISOLATION CLIP GUIDE

## RSIC-1 Clip UL Assemblies Approved for Use

### RSIC-1



CIKV.R16638

Types RSIC-1 and RSIC-1 (2.75) for use in Design Nos. G501, G502, G503, G504, G505, G507, G510, G512, G524, G525, G534, G551, G552, G561, G565, G578, G552, G565, L502, L505, L510, L511, L513, L514, L516, L518, L521, L523, L528, L532, L534, L542, L546, L547, L550, L562, L563, L569, L570, L573, L574, L576, L579, L582, L587, L589, L590, L593, M501, M502, M506, M508, M509, M510, M514, M531, P519, P522, P538, P545, P556, P571, U301, U305, U309, U311, U320, U331, U334, U340, U341, U342, U344, U356, U411, U415, U417, U419, U421, U423, U440, U451, U453, U455, U465, U473, U493, U524, U910, U914, V310, V323, V324, V438, V455, V469, V478, V481, V488, V489, V490, V496, V498, W419, W425, W440, W445.

Type RSIC-1 also Classified in accordance with ASTM E90-99, "Standard Test Method for Laboratory Measurement of Airborne Sound Transmission Loss of Building Partitions and Elements".

See Design Nos. G505, U305, U334, V310, for STC rating.

Type RSIC-1 also Classified in accordance with ASTM E492-96, "Standard Test Method for Laboratory Measurement of Impact Sound Transmission Through Floor-Ceiling Assemblies

Using the Tapping Machine". See Design No. G505 for IIC rating.

Types RSIC-1 and/or RSIC-1 (2.75) for use in Joint System Nos. HW-D-0060, HW-D-1011.



**ACOUSTICAL** | SURFACES, INC.

PAGE 7

*Celebrating Over 40 Years - SOUNDPROOFING, ACOUSTICS, NOISE & VIBRATION SPECIALISTS!*  
952.448.5300 | 800.448.0121 | sales@acousticalsurfaces.com | www.acousticalsurfaces.com

# RSIC-1 SOUND ISOLATION CLIP GUIDE

## RSIC-1 Clip Warranty

The RSIC-1 is the first and only product classified by UL for both fire and sound.



Members of the International  
Code Council

### WARRANTY DISCLAIMER AND LIMITATION LANGUAGE

#### **NO EXPRESS OR IMPLIED WARRANTIES**

THERE IS NO WARRANTY, REPRESENTATION OR CONDITION OF ANY KIND, AND ANY WARRANTY, EXPRESS OR IMPLIED IS EXCLUDED AND DISCLAIMED, INCLUDING THE IMPLIED WARRANTIES OF MERCHANTABILITY AND OF FITNESS FOR A PARTICULAR PURPOSE. Some states do not allow limitations on implied warranties, so the above limitation may not apply to you.

#### **LIABILITY LIMITED TO RETURN OF PURCHASE PRICE**

IT IS AGREED THAT SELLER'S LIABILITY AND PURCHASER'S SOLE REMEDY, WHETHER IN CONTRACT, UNDER ANY WARRANTY, IN TORT (INCLUDING NEGLIGENCE), IN STRICT LIABILITY OR OTHERWISE, SHALL NOT EXCEED THE RETURN OF THE AMOUNT OF THE PURCHASE PRICE PAID BY PURCHASER, AND UNDER NO CIRCUMSTANCES SHALL SELLER BE LIABLE FOR ANY SPECIAL INCIDENTAL OR CONSEQUENTIAL DAMAGES, INCLUDING, BUT NOT LIMITED TO, PERSONAL INJURY, PROPERTY DAMAGE TO OR LOSS OF EQUIPMENT, LOST PROFITS OR REVENUE, COSTS OF RENTING REPLACEMENTS AND OTHER ADDITIONAL EXPENSES, EVEN IF SELLER HAS BEEN ADVISED OF THE POSSIBILITY OF SUCH DAMAGES. THE PRICE STATED FOR THE EQUIPMENT IS CONSIDERATION IN LIMITING THE SELLER'S LIABILITY AND PURCHASER'S REMEDY. Some states do not allow the exclusion or limitation incidental or consequential damages, so the above limitation or exclusion may not apply to you.

#### **SELLER NOT LIABLE FOR PURCHASER'S NEGLIGENCE**

SELLER WILL NOT BE LIABLE FOR ANY DAMAGES, LOSSES OR EXPENSES AS A RESULT OF PURCHASER'S NEGLIGENCE, WHETHER DEEMED ACTIVE OR PASSIVE AND WHETHER OR NOT ANY SUCH NEGLIGENCE IS THE SOLE CAUSE OF ANY SUCH DAMAGE, LOSS OR EXPENSE.

#### **MODEL FOR DEMONSTRATION PURPOSED ONLY**

THE MODEL OR SAMPLE SHOWN BY SELLER TO BUYER IS USED FOR DEMONSTRATION PURPOSES ONLY. THERE IS NO WARRANTY THAT THE GOODS AS DELIVERED SHALL CONFORM TO THE MODEL OR SAMPLE, AND CONFORMITY OF THE GOODS TO THE MODEL OR SAMPLE IS NOT PART OF THE BASIS OF THE BARGAIN BETWEEN SELLER AND BUYER.

#### **NO WARRANTY OR COMPLIANCE WITH SAFETY CODE OR REGULATION**

SELLER DOES NOT WARRANT THAT ANY OF THE GOODS SOLD WILL MEET OR COMPLY WITH THE REQUIREMENTS OF ANY SAFETY CODE, BUILDING OR DWELLING CODE, OR REGULATION OF ANY STATE, MUNICIPALITY OR OTHER JURISDICTION.

#### **NEVADA LAW APPLIES**

SELLER AND BUYER AGREE THAT ALL ASPECTS OF THIS TRANSACTION INCLUDING THE APPLICABLE STATURE OF LIMITATIONS SHALL BE GOVERNED BY THE INTERNAL LAW OF THE STATE OF NEVADA, AND NOT THE LAWS OF CONFLICTS. This warranty gives you specific legal rights, and you may also have other rights which vary state to state.



**ACOUSTICAL | SURFACES, INC.**

PAGE 7

*Celebrating Over 40 Years - SOUNDPROOFING, ACOUSTICS, NOISE & VIBRATION SPECIALISTS!*  
952.448.5300 | 800.448.0121 | sales@acousticalsurfaces.com | www.acousticalsurfaces.com